

CUSTOMER: _____	TB-NIIGATA	SPECIFICATION NO. No.6CC711-049
LOCATION: _____		INQUIRY/ORDER NO. _____

INSTRUCTION MANUAL
(For General Use)

 **TB Global Technologies Ltd.**

2	CHANGED	Jul.26.'23	<i>M. Takami</i>		<i>K. Yoshida</i>	T.Hosaka	
1	CHANGED	Nov.05.'15	M.Takami	A.Nagai	<i>✗</i>	C.Tomii S.Tsukazaki	
0	ORIGINAL	Jan.17.'14	A.Nagai	M.Takami	<i>✗</i>	C.Tomii	
REV.	DESCRIPTION	DATE	APPR'D	CHK'D	CHK'D	PREP'D	CHK'D
			ENGINEERING DEPARTMENT				

TB-NIIGATA • SWIVEL JOINT INSTRUCTION MANUAL
(For General Use)

This manual explains how to use TB-NIIGATA • SWIVEL JOINT.

You can expect long life of TB-NIIGATA • SWIVEL JOINT if you handle it correctly.

1. Instruction for use

1.1 Working pressure

The pressure of the fluid flowing in the swivel joint shall be less the value shown in “Appendix 1 Maximum Working Pressure”.

(That is Maximum Working Pressure of the main body joint. Consequently, The Maximum Working Pressure is different depending on connected pipes and flanges etc.)

When manufacturing specification is supplied, the pressure shall be less than the value shown in the specification.

1.2 Style

The ball bearing part of the swivel joint is finished with high precision. The movement of the piping is accordingly limited in swivel direction. The style shall be carefully selected taking the movement of the piping in consideration.

1.3 Welding

When a swivel joint is attached to the piping by welding, observe “4. Instructions for welding”.

1.4 Lubrication

(1) Ball bearing part and sealing part must be always coated with lubrication grease to maintain smooth rotation of the swivel joint as well as to maintain perfect sealing function.

(2) Use the swivel joint as delivered because it is lubricated with grease before the shipment.

(3) Frequency of lubrication

In case of normal use swivel joint must be lubricated when the packing is renewed.

In case it is continuously rotated or used at high temperature, the swivel joint shall be periodically checked for lubrication and supplied with grease if necessary.

i) Remove the ball retainer plug of the swivel joint and visually check for change in color, hardening, deterioration and decrease of grease. Supply grease when at least one of above changes is recognized.

ii) Guideline of inspection frequency (lubrication frequency)

Recommendation:

for use in continuous rotation: every three months

for use at high temperature: every month

You have to set inspection frequency depending on the actual usage.

iii) Supply grease according to “3.3 (6) Supply of grease”.

1.5 Packing

During long use of a swivel joint sealing function of the packing is gradually degraded to cause a small leak showing exudation or drip. The life of the packing finishes at this point and shall be replaced with a new one.

The replacement shall be made according to “3. Disassembly and reassembly”.

Depending on circumstances the whole swivel joint must be replaced.

1.6 Rotation

Swivel joint is not rotary joint and is therefore not suitable to be rotated continuously.

However, it may be rotated under not very severe conditions.

1.7 Moment Load

The moment load is one of the important matter that influences the life of the Swivel Joints.

Also even the influence by the vibration etc. at the time of the misalignment, operation of piping think by the distance from the bearing of the weight thing and joint that are attached to piping and please pay attention sufficient on the occasion of the design.

1.8 Storage and initial use

(1) For heat resistant type swivel joint, gland packing is used for dust seal. Water splash on it shall be avoided because water may intrude into ball bearing part and cause rust.

(2) At initial usage of a stored swivel joint after delivery, the movement of joint may be tight.

In this case it must be rotated several times before use until it swings smoothly.

(3) In case of handling of solidifying liquid, the swivel joint shall not be rotated if it has already solidified. Otherwise the solid may be dragged in and give damage to the packing that may cause degradation of the seal.

Packing chamber of the swivel joint shall be fully cleaned not to keep solid residue inside.

All above are the instructions for general use of swivel joint. Please contact your dealer for more information.

2. Structure of swivel joint

An example of structure of swivel joint (Example: Silver 1") is shown below.

It features smooth rotation with a swing, a coupling and double race ball bearing and effective seal by inside packing system against inner fluid.

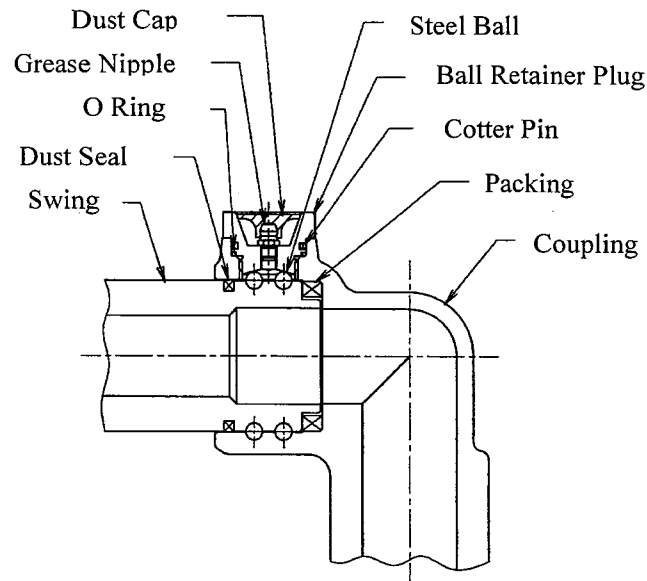

3. Disassembly and reassembly

3.1 Disassembly

(1) Removal of ball retainer plug

- i) In case of screw type ball retainer plug, pull out cotter pin or wire, and then remove ball retainer plug and O-ring by using spanner or flathead screwdriver.
- ii) In case of snap ring type ball retainer plug, remove the snap ring by using plier and then take out ball retainer plug by picking at the center of ball retainer plug with a scriber etc. and tilting the joint slightly.

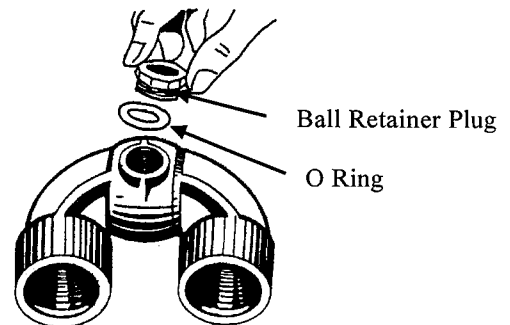

(2) Removal of ball

Make the holes of ball retainer plug upside down and rotate swing to let balls inside roll out. When it is difficult to rotate the swing, then rotate the coupling instead to take out the balls. If the swivel joint is hard to rotate, pour white gasoline etc. to loosen the tightened part.

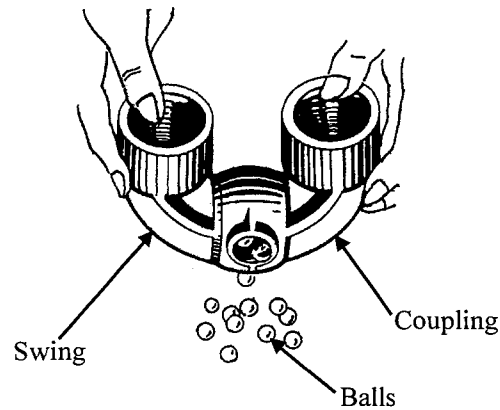

⚠ Warning: Danger

When white gasoline etc. is applied, make sufficient ventilation and take enough care not to cause fire.

(3) Disassembly

After taking out all balls swivel joint can be separated to coupling and swing.

⚠ Caution

Take care not to damage ball race and sealing surface of swivel joint.

(4) Removal of packing

⚠ Caution

Avoid using scriber or similar to remove packing. If sealing surface of swivel joint is even slightly damaged, it may cause leakage.

(5) Removal of grease retainer ring and dust seal

⚠ Caution

Take care not to damage sealing surface of swivel joint.

3.2 Inspection of removed parts

(1) Oil, dirt and attachment on the removed parts must be cleaned using suitable cleaner.

⚠ Warning: Danger

Make sufficient ventilation when cleaner is used.

⚠ Caution

Take care not to damage sealing surface and ball race surface.

(2) Ball race and sealing surface

Inspect ball race for crack, brineling, corrosion etc.. Very small defect may be removed using fine (more than #600 grade) sandpaper.

If the defect is hard to remove with sandpaper, that whole swivel joint shall be replaced.

3.3 Reassembly

When swivel joint is reassembled after disassembly and inspection, all parts except for the main body of swivel joint shall be replaced with new ones. Reassembly is to be made in the opposite order of disassembly. Take enough care not to include foreign particles attached on ball bearing part as well as on sealing part.

(1) Lubrication with grease

Apply suitable grease for the application thin and uniform on the packing, grease retainer ring, ball race and sealing surface.

Application		Grease
General use	Low pressure	Multi-purpose type
	High pressure Extra high pressure	Extreme pressure multi-purpose type
High temperature		Resist high temperature type
Other than those above		Silicon grease, etc.

(2) Mounting of grease retainer ring or dust seal

The grease retainer ring shall be fitted to the ring groove carefully making the direction of the lip as shown in the diagram.

The dust seal shall be adjusted with its length and then fitted in the ring groove.

⚠ Caution

Grease retainer ring shall not be stretched too much.

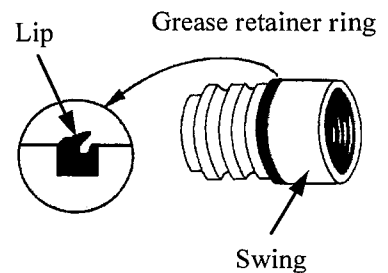

(3) Insertion of packing

Be sure that outer ring (metal ring) is attached to the circumference of the packing. The outer ring is necessary to prevent the packing from protruding to the ball race side.

i) A-Type

When packing is inserted, make sure that the outer ring faces to the near side (ball race side).

ii) B-Type

The packing is allowed to face to either side.

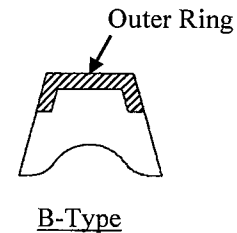
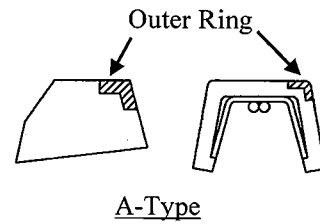

(4) Insertion of ball

i) Fix surely the coupling not to move. It makes it easier to mount the swing on the coupling.

⚠ Caution

Avoid labored mounting or protrusion of grease retainer ring.

ii) Insert swing so that coupling aligns with ball race of the swing.

⚠ Caution

Avoid inserting the swing too far.

iii) First prepare two balls for compressing the packing.

iv) Insert a ball by tapping with a rod that makes it easier to insert the next ball.

⚠ Caution

When tapping with a rod, take care not to damage the insertion hole.

v) Necessary number of balls shall be surely inserted to fill each ball race full. When the last ball is tapped with a rod, the first ball comes out. Check whether all necessary balls are inserted in each ball race.

As for number of steel balls refer to “Appendix 2 Size and number of steel balls per swivel”

(5) Mounting of ball retainer plug

i) Screwed type ball retainer plug

Fit O-ring first and then screw ball retainer plug into the body.

For high pressure swivel joint use a cotter pin or wire to prevent loosening.

ii) Rubber ball retainer plug

Insert ball retainer plug and fit snap ring by using plier.

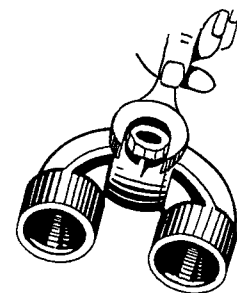
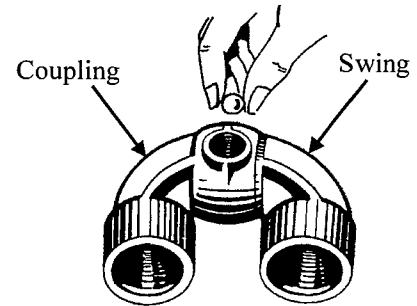

(6) Supply of grease

- i) Screw grease nipple into the lubrication hole. In case there are two lubrication holes diagonally on the circumference of swivel, attach grease nipple on a lubrication hole while keeping another hole open.

Use grease nipple suitable for the lubrication hole.

Size of thread of grease nipple:

- NF1/4 : Green, Blue, SST, type N (2-1/2" to 4"), Silver, type SN, Orange (3/8" to 2")
 - R1/8 : type N (6" to 12"), Orange(2-1/2" to 5").
- ii) Fill a small amount of grease slowly into grease nipple by manual grease gun while keeping the swing rotating slowly.
- As for filling amount of grease refer to "Appendix 3 Filling amount of grease after disassembly and reassembly of swivel joint".
- iii) Every stroke of grease gun discharge excess grease by pushing the ball at the top of the grease nipple.
- iv) In case swivel joint becomes hard to rotate during lubrication, too much grease may have been filled. Push the ball at the top of grease nipple to discharge excess grease.
- v) When grease comes out from dust seal part or nipple hole, stop supplying grease.
- vi) Rotate swivel joint several times after lubrication, push ball of grease nipple or dismount grease nipple to discharge excess grease and release pressure of grease in the swivel joint.
- vii) Screw grease nipple or grease fitting plug into the nipple hole.

 **Caution:**

Take care not to fill too much grease. If grease pressure remains, the packing may be deformed to cause leakage as well as disturbance of rotation.

3.4 Confirmation of smooth rotation

Confirm swivel joint rotates smoothly after completion of reassembly.

4. Instructions for welding

Pay attention to the followings when swivel joint is welded to piping.

4.1 Disassemble swivel joint before welding.

This is necessary to protect packing and grease retainer ring from excess heat and to prevent degradation of grease.

Disassembly shall be made according to “3. Assembly and disassembly”

4.2 Pipe and swivel joint body are tentatively mounted and welded to confirm neither eccentricity nor tilt exists and then open up full welding

(1) During welding bind up wet cloth etc. to prevent heating up of the ball race part over 80°C.

(2) Take care not to damage machined surface of the swivel joint during welding work.

Cover the finished surface not to be attached with spatter of welding.

(3) After completion of welding clean the ball race part, packing, sealing surface of dust seal with cleaner.

 Warning: Danger

Make sufficient ventilation when cleaner is used.

4.3 Assembly of swivel joint shall be made according to “3. Assembly and disassembly”.

Appendix 1 Maximum working pressure

Application	Type	Size	Maximum working Pressure (MPa)
Low Pressure	Green	3/8"~4"	2.06
	Blue	3/8"~12"	3.43
	SST	3/8"~8"	2.06
	Type N	2 1/2"~4"	3.43
		6"~12"	2.06
High Pressure	Silver	3/8"~1"	20.59
		1 1/4"~2 1/2"	10.30
	Type SN	3", 4"	10.30
Extra High Pressure	Orange	3/8"~2"	34.32
		2 1/2" ~5"	20.59

Note: In case manufacturing specification is supplied follow that specification.

Appendix 2 Size and number of steel balls per one swivel

Type \ Size		3/8" ~1/2"	3/4" ~1"	1 1/4" ~1 1/2"	2"	2 1/2"	3"	4"	5"	6"	8"	10"	12"
Green	Size	3/16	1/4	1/4	3/8	3/8	3/8	3/8	—	—	—	—	—
	Number	34	40	54	48	66	66	84	—	—	—	—	—
Blue	Size	3/16	1/4	1/4	3/8	3/8	3/8	3/8	5/8	5/8	5/8	5/8	5/8
	Number	34	40	54	48	66	66	84	68	76	96	116	140
SST	Size	3/16	1/4	1/4	3/8	3/8	3/8	3/8	—	5/8	5/8	—	—
	Number	34	40	54	48	66	66	84	—	76	96	—	—
Type N	Size	—	—	—	—	3/8	3/8	3/8	—	3/8	3/8	3/8	3/8
	Number	—	—	—	—	66	66	84	—	118	150	186	218
Silver	Size	3/16	1/4	1/4	3/8	3/8	—	—	—	—	—	—	—
	Number	42	42	54	52	62	—	—	—	—	—	—	—
Type SN	Size	—	—	—	—	—	1/2	5/8	—	—	—	—	—
	Number	—	—	—	—	—	56	56	—	—	—	—	—
Orange	Size	1/4	1/4	3/8	3/8	1/2	1/2	5/8	5/8	—	—	—	—
	Number	42	54	52	62	84	84	84	102	—	—	—	—

Appendix 3 Filling amount of grease after assembly and disassembly of swivel joint

(Unit:cm³)

Size Type	3/8" ~1/2"	3/4" ~1"	1 1/4" ~1 1/2"	2"	2 1/2"	3"	4"	5"	6"	8"	10"	12"
Green	1	2	4	8	10	10	15	—	—	—	—	—
Blue	1	2	4	8	10	10	15	50	60	80	90	100
SST	1	2	4	8	10	10	15	—	60	80	—	—
Type N	—	—	—	—	10	10	15	—	25	30	50	60
Silver	1	3	4	10	10	—	—	—	—	—	—	—
Type SN	—	—	—	—	—	20	40	—	—	—	—	—
Orange	3	4	10	10	30	30	60	75	—	—	—	—

Note: The above values are filling amount per swivel for reference.